

# The Core Family

Welcome to the Core line of fixtures. You will find a rich diversity of technical and aesthetic options with over 14 finishes including custom wood trims, flux and source selections featuring 90+ CRI fixed white and our world class Ambient Dim (Warm Dim), a 3.7:1 uniformity ratio from top to bottom of the wall and plethora of driver and control choices. The Core wall wash is created on a platform allowing a high degree of modification, so if you don't see what you are looking for, just ask.

4" Square WW Z (Flangeless)

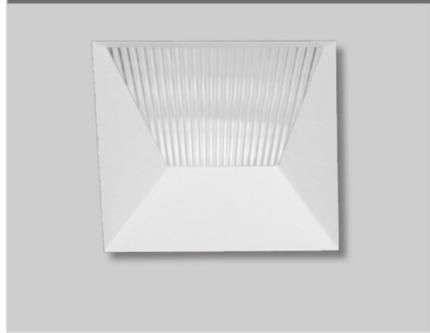

4" Square WW F (Flanged)

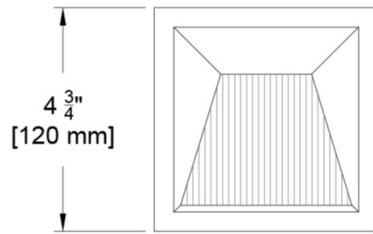
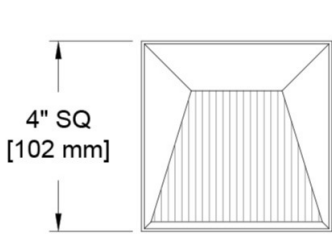
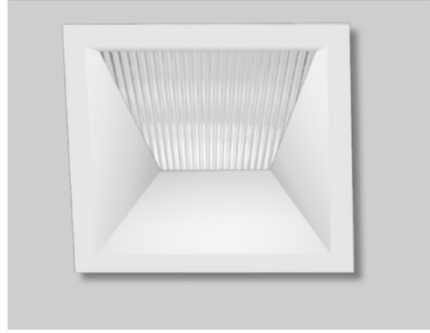

Wood Trim Available

PROJECT:

TYPE:

SPECIFIER:

DATE:

## Key Points (CR4WW-SF)

### Trim

- Flanged or Flangeless
- Frosted Supertex borosilicate glass spread lens, hinged for source and driver service
- Flangeless includes plaster flange with lip
- 14 color options + custom, RAL or wood available
- One-piece die cast aluminum or machined wood trim

### Source / Optics

- 2400K, 2700K, 3000K, 3500K, 4000K Ambient Dim, RGBW & Tunable White options
- 90 CRI, 60+ R9 Standard- 95 CRI 90+R9 Optional
- <2 MacAdam Steps (<2SDCM) for fixed white
- Up to 1069 delivered lumens
- Uniform light from floor to ceiling. Achieves a 3.7:1 ratio on a 10' ceiling at 2.5' setback with a 1:1 on center spacing

### Housing

- Compliant to with Airtight Housing
- Listed – Damp or wet with shower trim
- Approved for 8 (4-in / 4-out) #12 AWG conductors rated for 90°C through wiring
- IC Rated / Airtight Housing approved for use in direct contact with insulation – Chicago Plenum Available
- Heavy gauge aluminum for new construction or remodel

### Driver

- TruPhase™, 0-10, DALI-2, DMX, Ecosystem or Wireless Control
- Flicker free to IEEE 1789-2015
- Prewired and integral to housing
- Universal 120-277v

# Ordering Codes

PROJECT: \_\_\_\_\_ SPECIFIER: \_\_\_\_\_

DATE: \_\_\_\_\_ TYPE: \_\_\_\_\_ QUANTITY: \_\_\_\_\_

Ordering Code Example: CR4WW-SF-F-AU-C20-35-E2-P16-CP

FIXTURE	TRIM	MOUNTING	SOURCE / WATTS	CCT	DRIVER / CONTROL	TRIM FINISH	ACCESSORIES
<p><b>CR4WW-SF</b></p> <p>Core 4" Square Fixed Wall Wash</p>	<p><b>Flanged Trims</b></p> <p><b>F</b> Flanged Trim</p> <p><b>FS</b> Flanged Shower Trim <i>(for mounting choose from Flanged Housings)</i></p> <p><b>Flangeless Trims</b></p> <p><b>Z</b> Flangeless Trim</p> <p><b>ZS</b> Flangeless Shower Trim <i>(for mounting choose from Flangeless Housings)</i></p>	<p><b>Flanged Housings</b></p> <p><b>U</b> Universal - Non IC Housing</p> <p><b>AU</b> ● ● Airtight Universal IC-Rated</p> <p><b>Flangeless Housings</b></p> <p><b>P</b> Plaster</p> <p><b>PM</b> Panel Mount</p> <p><b>APM</b> ● ● Airtight Panel Mount IC-Rated</p> <p><b>AP</b> ● ● Airtight Plaster IC-Rated</p> <p><b>Shallow Housing</b></p> <p><b>ASU</b> * ● ● Airtight Shallow Universal IC-Rated</p> <p><b>ASPM</b> * ● ● Airtight Shallow Panel IC-Rated</p> <p><b>ASP</b> * ● ● Airtight Shallow Plaster IC-Rated</p> <p>● ● California Title Compliant</p>	<p><b>Citizen</b></p> <p><b>C14</b> ● ● 15W 679Lm 90+CRI, 60+R9</p> <p><b>C20</b> 21W 832Lm 90+CRI, 60+R9</p> <p><b>C28</b> 30W* 1069Lm 90+CRI, 60+R9</p> <p><b>Tunable</b></p> <p><b>T9</b> 90+CRI, 60+R9 Tunable White</p> <p><b>T15</b> 90+CRI, 60+R9 Tunable White</p> <p><b>T20</b> ● ● 21W 90+CRI, 60+R9 Tunable White</p> <p><b>RGBW</b> 90+CRI, 60+R9</p> <p><b>Ambient Dim™</b></p> <p><b>A14</b> 15W 461Lm 95+CRI, 90+R9</p> <p><b>A20</b> ● ● 21W 95+CRI, 90+R9</p> <p>● ● California Title 24 Compliant to JA8</p> <p>* Requires Active Cooling and Non-IC housing. Not compatible with L2 and LP drivers.</p>	<p>24 2400K</p> <p>27 2700K</p> <p>30 3000K</p> <p>35 3500K</p> <p>40 4000K</p> <p><b>Tunable</b></p> <p><b>TW1840</b> 1800-4000K Tunable White w/ E1, E2, E3, E4</p> <p><b>TW2765</b> 2700-6500K Tunable White w/ E1, E2, E3, E4</p> <p><b>RG1280</b> 1200-8000K RGBW Dynamic Color Changing *Requires E2 or E4</p> <p><b>Ambient Dim™</b></p> <p>2722* 2700-2200K *A14 Only</p> <p>3019 3000-1900K</p> <p>3022* 3000-2200K *A14 Only</p>	<p><b>C1</b> 0-10 1.0%, UNV (120-277V) linear</p> <p><b>C2</b> ELV/Triac 1.0%, (120V) linear</p> <p><b>E1</b> 0-10 0.1%, UNV (120-277V) log</p> <p><b>E2</b> DALI-2 0.1%, UNV (120-277V) log</p> <p><b>E3</b> 0-10 0.1%, UNV (120-277V) linear</p> <p><b>E4^</b> DMX 0.1%, UNV (120-277V) Universal DMX Driver/Controller RGBW-DMX ^ INCLUDES DMX/RDM COMPATIBLE DRIVER WITH BUILT-IN DECODER - CONTROLLER BY OTHERS</p> <p><b>LD</b> Digital Ecosystem 1.0%, UNV (120-277V) ECO Hi-Lume SoftOn/Fade-to-Black LDE1</p> <p><b>TR2</b> TruPhase™ 0.1%, (120-120V) log Up to 20W Forward and Reverse compatible Phase Dimming Static White &amp; Ambient Dim only</p> <p>* Not compatible with C28 Source</p>	<p><b>W</b> White Paint</p> <p><b>B</b> Black Paint</p> <p><b>D</b> Wood*</p> <p><b>PXX</b> Specialty Paint Color*</p> <p><b>C</b> Custom/RAL Color**</p> <p>*See wood trim guide. **See Finish Guide</p> <p><b>FINISH GUIDE LINK</b></p> <p><b>WOOD TRIM GUIDE</b></p>	<p><b>EM</b> Emergency Pack</p> <p><b>CP</b> Chicago Plenum</p> <p><b>Controls</b></p> <p><b>LR</b> Lutron Wireless RF PowPak</p> <p><b>ATH</b> Lutron Athena Wireless Node <i>Must be used with E2 driver</i></p> <p><b>CA</b> Casambi Wireless BLE to be paired with driver</p>

# Ceiling Cutouts and Dimensions

## Square Flangeless Housing

### Plaster Mount (P/AP)

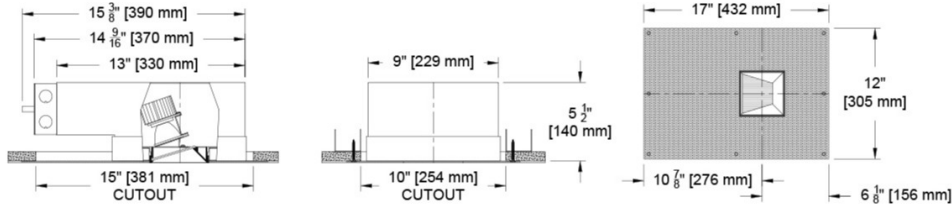

## Square Flangeless Housing

### Plaster Mount (P) C28 Only\*

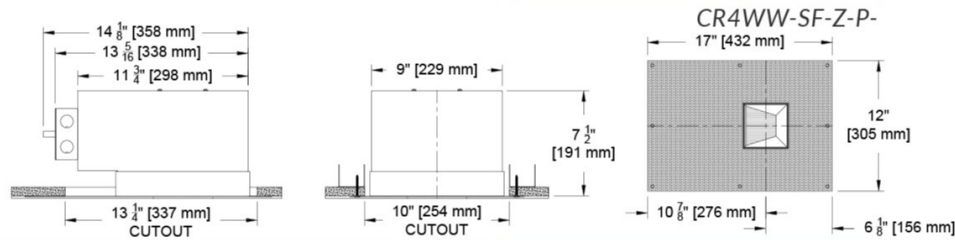

## Square Flanged Housing

### Universal Mount (U/AU)

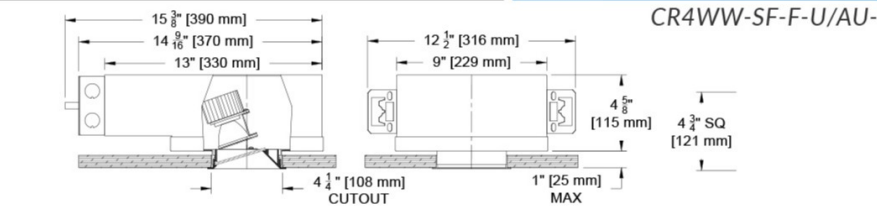

## Square Flangeless Housing

### Universal Mount (U/AU)

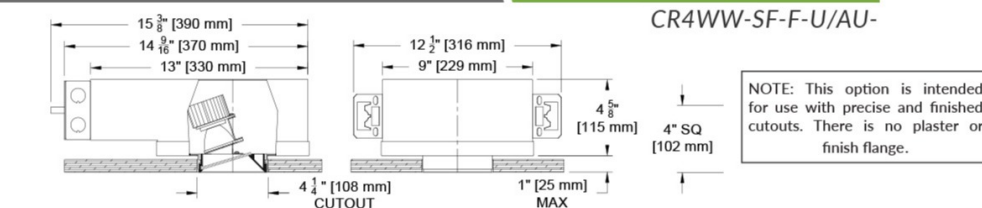

## Square Flangeless Housing

### Panel Mount (PM/APM)

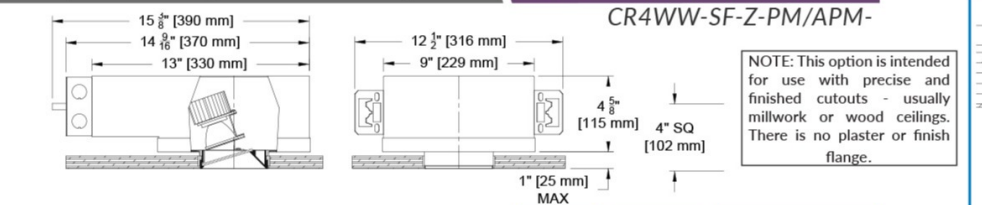

## Square Universal Housing

### (U) (PM) C28 Only\*

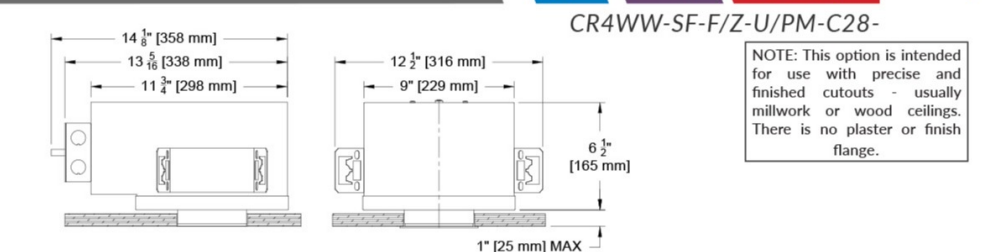

## Hanger Bar Detail

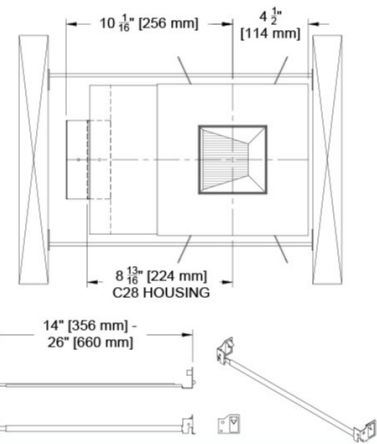
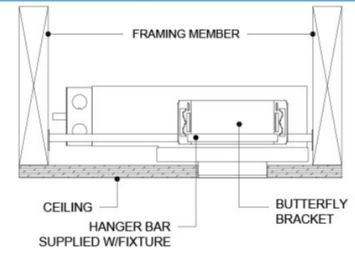

## Panel Mount Detail

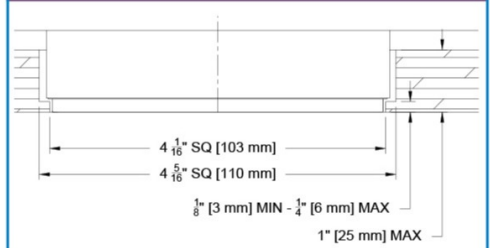

# Ceiling Cutouts and Dimensions

## Square Flangeless Housing

### Airtight Shallow Plaster (ASP)

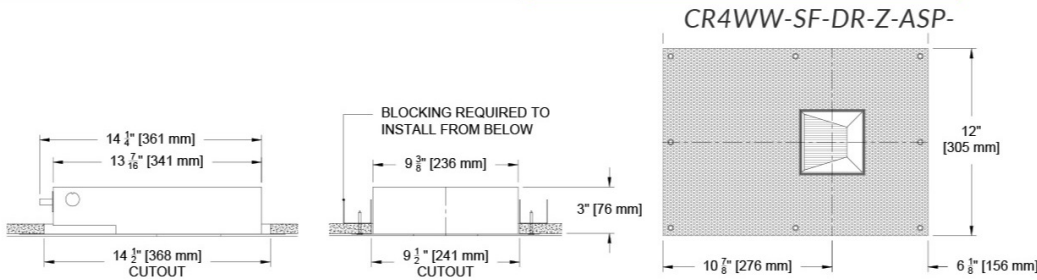

## Hanger Bar Detail

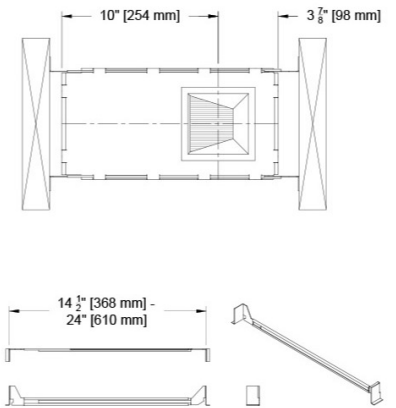
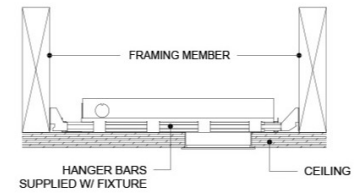

## Square Flanged Housing

### Airtight Shallow Universal (ASU)

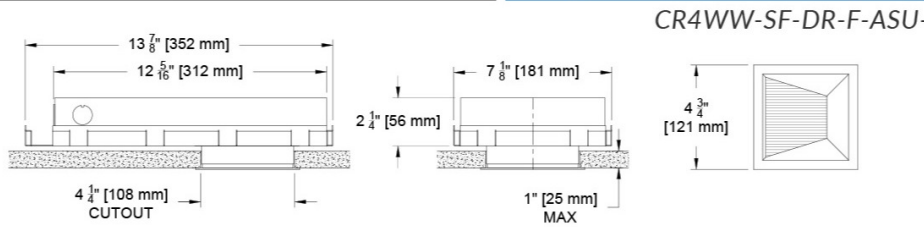

## Square Flangeless Housing

### Airtight Shallow Universal (ASU)

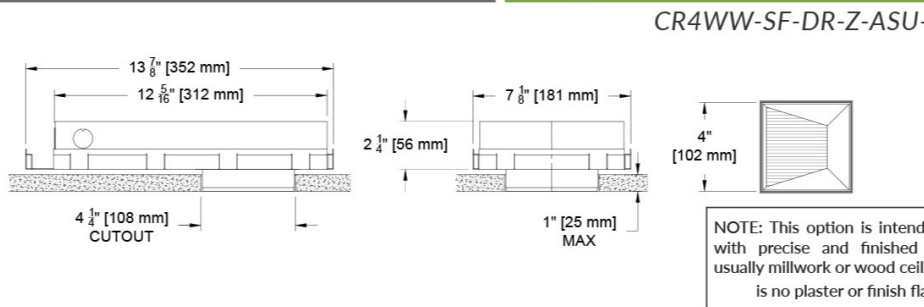

## Panel Mount Detail

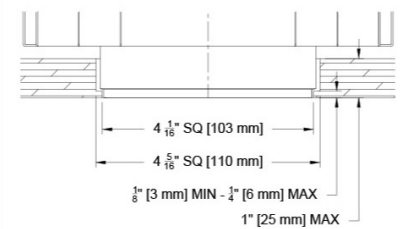

## Square Flangeless Housing

### Airtight Shallow Panel (ASPM)

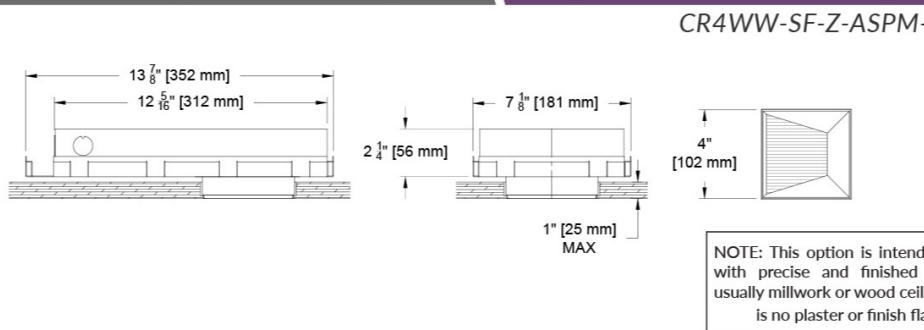

# Photometric Table

All data is based from goniometer measurements of production representative product. All lumen values can vary +/- 10% from LED manufacturer rated flux range. Measurements at 3000 CCT. C28 source requires active cooling and must be used with NIC housing for required airflow. C14 is the only source to meet CA Title 24 /JA8 requirements. All values can vary +/-10% from source manufacturer rated flux range.

All data below is based from goniometer measurement of production representative product. All lumen values can vary +/- 10% from LED manufacturer rated nominal flux.

SQUARE Wall Wash (CR4WW-SF)			
Source	System watts (W)	Delivered Lumens (lm)	Lumens/ Watt
Citizen C14	14	679	49
Citizen C20	21	832	40
Citizen C28*	30	1069	35
Ambient Dim A14	15	461	31

CCT Multiplier	
CCT	Citizen
2700	0.95
3000	1.00
3500	1.02
4000	1.03

All data based on 3000k in fixed position (CR4WW-SF). Ambient Dim based on 3000k at full output. \*C28 requires active cooling and cannot be used with IC housing, Chicago Plenum or LP Driver.

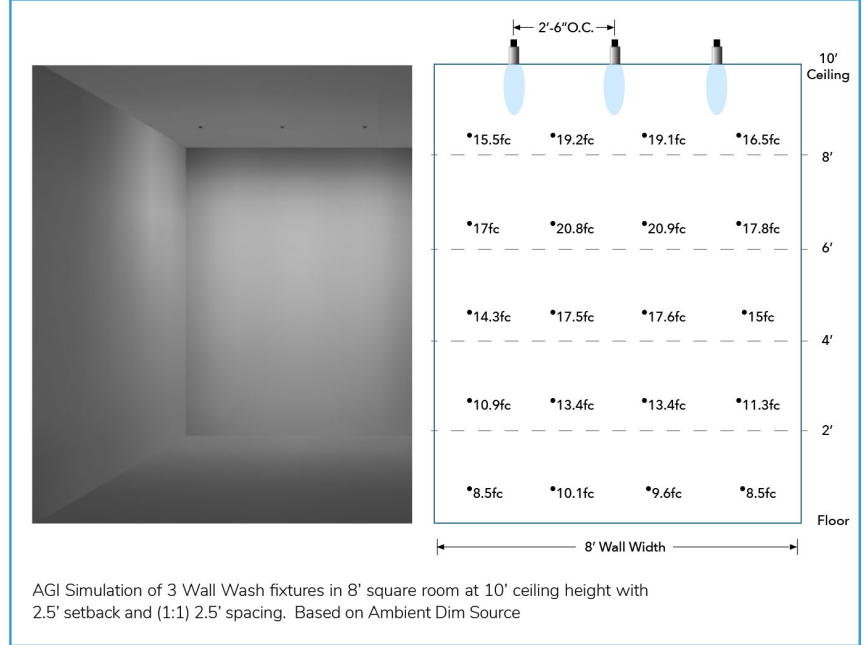

# Color Data

All data is based from goniometer measurements of production representative product. All values can vary +/- 10% from LED manufacturer rated data range. Measurements at 3000 CCT.

## Citizen Sources - C14, C20 and C28

- <2 MacAdam Ellipse (<2 SDCM)
- 90+ CRI and RF
- 60+R9, Hue Bin 1

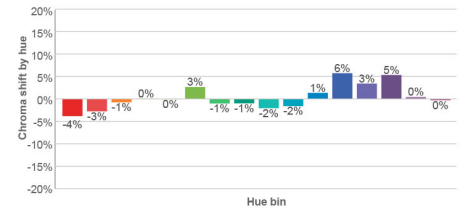
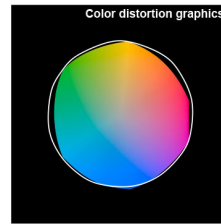
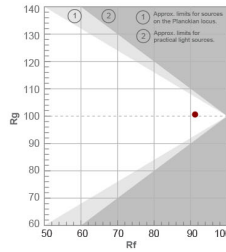
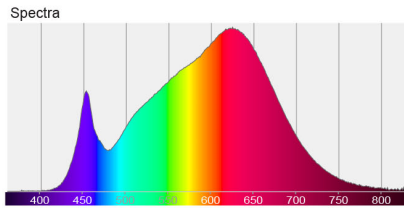
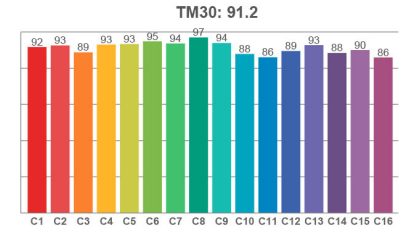
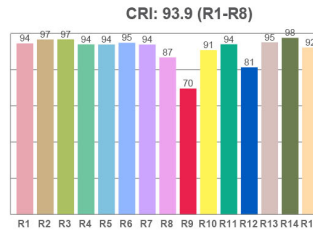

## Ambient Dim - 3000k to 1900k

- <3 MacAdam Ellipse (<3 SDCM)
- 95+ CRI and RF
- 90+R9, Hue Bin 1
- Follows Black Body Locus through dimming range

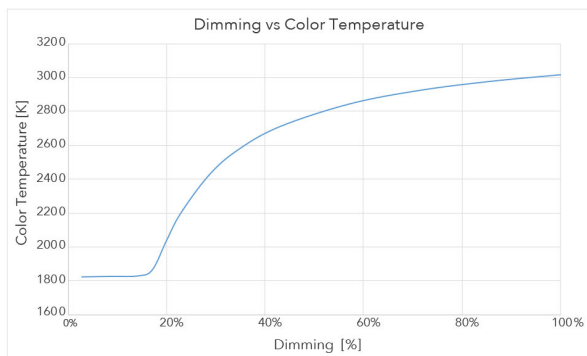

### 3000 CCT Full Output

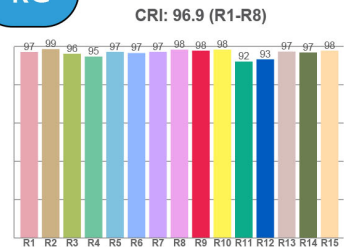
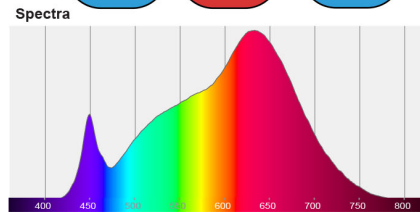

### 1850 CCT 5% Output

